



LED UV-A LAMPS 2026



relinc.com



Glo-Black LED UV-A Lamps

PROFUSION	4	C4 MAGNUM	54
PROFUSION XW	14	C4 MAGNUM-GO	64
C4 NOMAD	24	LIQUID STYLUS	70
C4 NOMAD-GO	34	REL TAM PANELS	78
NOMAD-ASCENT	40	NOMAD-DER	82
NOMAD-ECLIPSE	48	REL PRODUCT INTEGRATION	86
FPI MOBILE TESTING NOMAD KIT	52	ACCESSORIES	88
BOLT-ON POWER	53		



LED UV-A LAMPS

Complex Challenges. Convenient Solutions.

REL, Inc. has created the most robust UV-A lamps available to the world NDT market.

We originally developed our LED UV-A inspection lamps as an enhancement to our non-destructive testing equipment. We couldn't find another lamp that was up to the demanding use case of 'REL normal operating conditions.' These conditions are modeled after reality, where products get dropped, kicked, and run over. The lamp product MUST work during and after these sudden and realistic events. In fact, we guarantee it will. When you buy our product, we warranty ANY damage you think should be covered, PERIOD. The result is a bulletproof, versatile, easy-to-use lamp that is sensitive enough for the clean room, and strong enough to withstand continuous use in the harshest industrial environments.

REL, Inc. inspection lamps are designed for all power and intensity prerequisites of Fluorescent Penetrant Inspection (FPI), Magnetic Particle Inspection (MPI), and a plethora of leak detection applications as set forth in the aerospace, automotive, defense, energy, and medical industries. Each lamp utilizes safe, high yield, LED UV-A technology, and contains a high flux LED UV-A emitter with a built-in electrostatic discharge circuit, robustly coupled to a passively cooled IP67 machined military-grade aluminum housing to enable the light to perform to specification and your expectations!



PROFUSION LED UV-A LAMP



1 REL Profusion Module vs 1 fluorescent fixture

Single Profusion

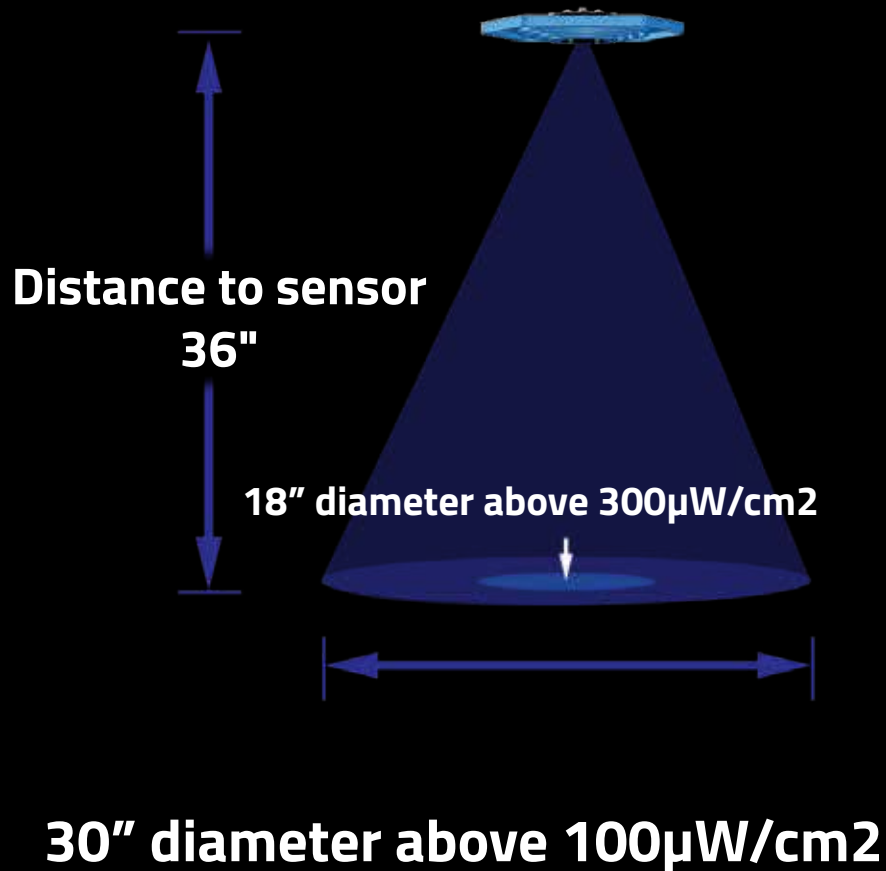

Two 4 ft mercury vapor bulbs

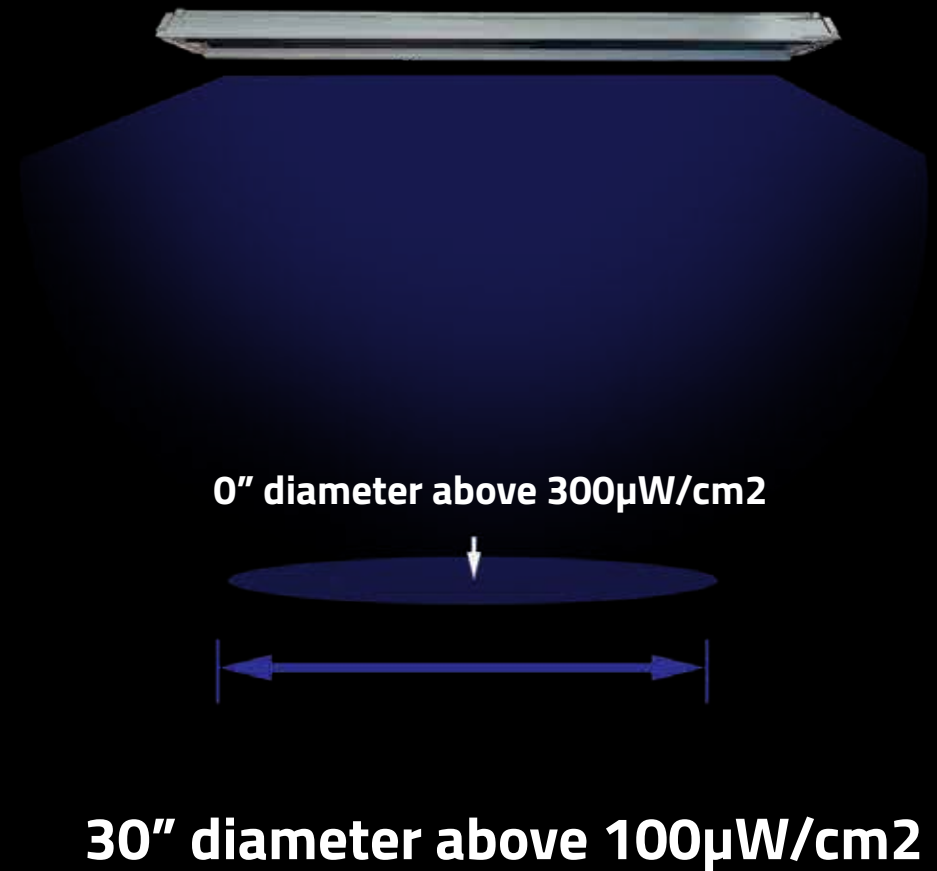

PROFUSION CHARACTERISTICS

<i>Performance Attributes</i>	<i>Parameters</i>
Maximum Irradiance (at 15 in/38cm)	5000 $\mu\text{W}/\text{cm}^2$
Peak Wavelength	365 \pm 5 nm
Irradiance at Peak Wavelength (at 15 in)	> 200 $\mu\text{W}/\text{cm}^2$
Typical Irradiated Area (profile at 15 in)	Circular Spot 10" Diameter > 1000 $\mu\text{W cm}^2$ (347-382 nm)
Emission Spectrum	
Full Width at Half Maximum (FWHM)	\leq 15 nm
Longest Wavelength at Half Max (LWHM)	\leq 377 nm
Full width at 10% Maximum	\leq 30 nm (\pm 15)
Excitation Irradiance (347-382 nm)	> 2500 $\mu\text{W}/\text{cm}^2$
Wavelength Drift (at 70° F ambient)	\leq 3 nm
Working Distances	
ASTM E3022	Minimum WD \leq 5 in
RRES 90061	Minimum WD = 12 in
	Maximum WD = 23"
Typical Visible Emission (390-800 nm)	
ASTM E3022	\leq 2 ft candles
RRES 90061	\leq 20 lux at 15 in

<i>Physical Attributes</i>	<i>Parameters</i>
Operating Environment	32 - 115° F
Maximum Housing Temperature (at 70° F ambient)	104° F
Lamp Cord Length	10 ft standard
Power Supply Cord Length	Sized per array
Weight	3.08 lb (1 module)
Specification Compliance	ASTM E3022, RRES 90061, ISO 3059, Airbus AITM 6-1001

Emission Spectrum measured at Stabilization Temperature

Single lamp module

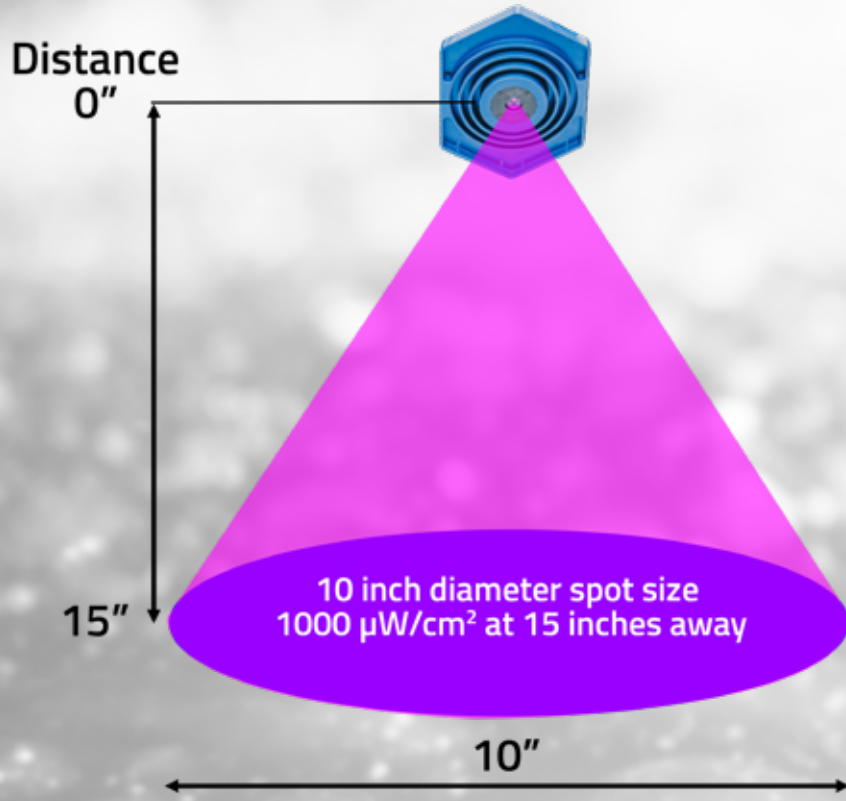

UV-4000TB (3 lamp module)

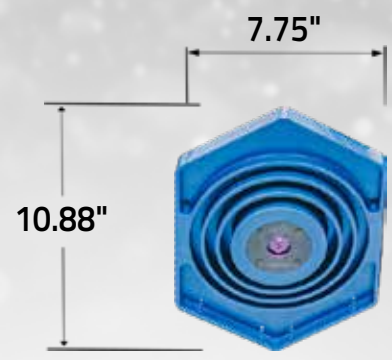
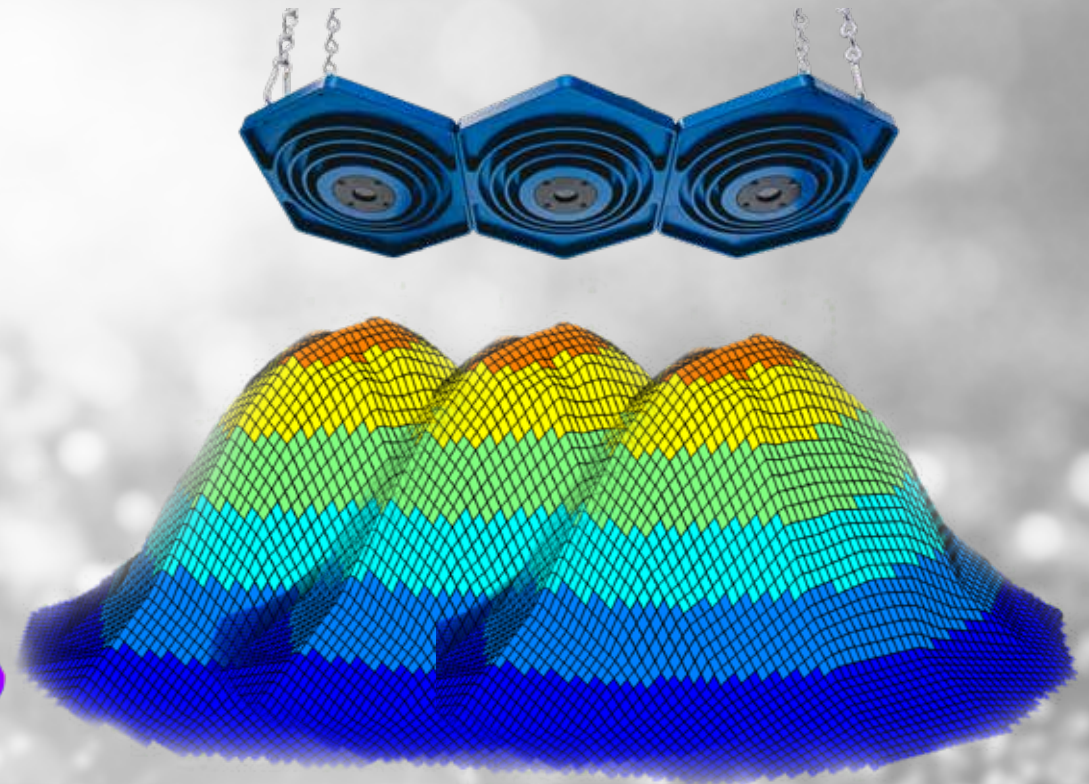

PROFUSION COMMON CONFIGURATIONS

Coverage Area
>1000 $\mu\text{W}/\text{cm}^2$

UV-4000TB

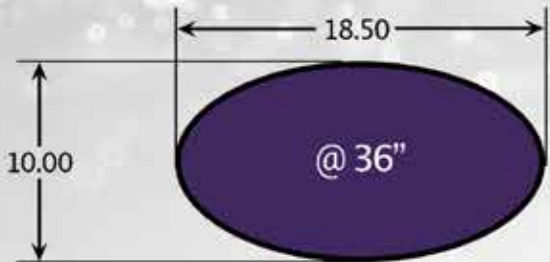
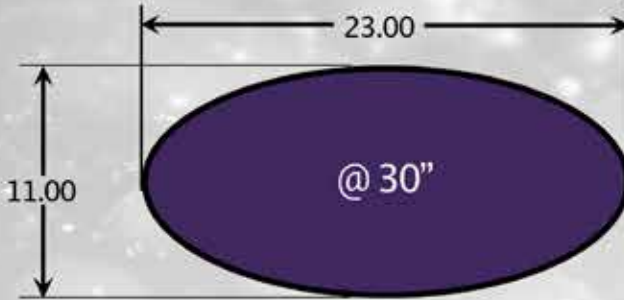
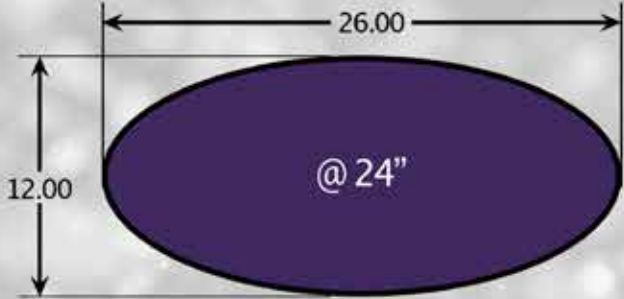

UV-4000DB

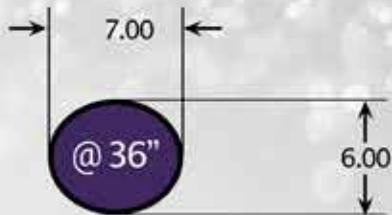
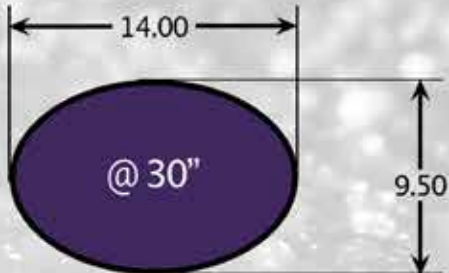
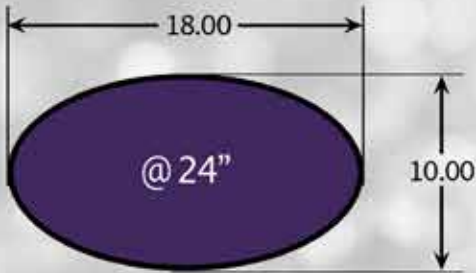

PROFUSION

REL's classic Profusion overhead UV-A inspection lamps are an expandable and configurable modular system for stationary non-destructive testing applications.

The Profusion is designed for all intensity requirements of Fluorescent Penetrant Inspection (FPI) and Magnetic Particle Inspection (MPI). Each Profusion module provides a 10-inch diameter of UV-A intensity above 1000 $\mu\text{W}/\text{cm}^2$ at 15 inches. The integral filter in the Profusion limits the visible light to 20 lux at 15 inches and 5 lux at 36 inches. Each Profusion module contains LED emitters with a built-in static-electric discharge circuit.

The lamp's electrical components are sealed and passively cooled with an engineered finned housing manufactured from military-grade aluminum. The IP68 rated housing allows the lamp to perform in all environments regardless of ambient conditions.



1. UV-4000TB with Profusion Hanging Hardware Kit, and Profusion Joining Plate & Connecting Wire Kit.
2. Glo-Black Profusions survive the toughest, wettest, and most severe work environments.
3. UV-4000 (1 plate kit) with Profusion Hanging Hardware Kit, and Profusion Shield Kit.
4. Profusion modules in an Inspection booth on REL's human-driven Model I2C FPI line.

Profusion Certifications & Compliances

- Tested & Complies with ASTM E3022 STANDARD
- Tested & Complies with ROLLS-ROYCE RRES 90061 REQUIREMENTS
- Tested & Complies with AIRBUS AITM 6-1001
- Meets Specifications ISO 3059
- IP68 Rated – Dust Sealed & Waterproofed
- 2 Year Warranty Guarantee
- Serialized Certificate of Conformance

Profusion Features and Benefits

- Modular & conformable system available in single, double bank, triple bank, or custom configurations
- 10-inch diameter of UV-A intensity above 1000 $\mu\text{W}/\text{cm}^2$ at 15 inches
- Integral filter limits visible light to 20 lux at 15 inches and 5 lux at 36 inches
- Low Voltage (Lamp input voltage 24V)
- Built-in static-electric discharge unit safety feature
- Clear indicators for lamp on/off operation
- Passive cooling via engineered finned housing with military-grade aluminum
- Power Supply input Voltage 100V - 240V AC
- Individual lamp module dimensions: 11.88" H x 7.75" W
- Individual lamp module weight (not including mounting hardware): 3.08 lbs.
- Refurbishable

The image shows three blue, hexagonal UV-A lamps hanging from a chain in an industrial setting. The lamps are arranged in a row and are illuminated, casting a bright blue glow. The background is a dark, industrial environment with various metal structures and equipment. The text "Optimize your rinse & inspection booths with Profusion LED UV-A Lamps." is overlaid on the image in white font.

Optimize your rinse & inspection booths
with Profusion LED UV-A Lamps.

PROFUSION: COMMON WAYS TO BUY

UV-4000 (1 lamp module)	Kit Includes
	<ul style="list-style-type: none"> ▪ Glo-Black Profusion LED UV-A Lamp Module ▪ 120/240V, 60W Power Supply ▪ 10' DC Extension Power Cord ▪ Profusion Hanging Hardware Kit
UV-4000DB (Double Bank)	Kit Includes
	<ul style="list-style-type: none"> ▪ 2 - Glo-Black Profusion LED UV-A Modules ▪ 120/240V, 60W Power Supply ▪ 10' DC Extension Power Cord ▪ Profusion Connecting Kit ▪ Profusion Hanging Hardware Kit
UV-4000TB (Triple Bank)	Kit Includes
	<ul style="list-style-type: none"> ▪ 3 - Glo-Black Profusion LED UV-A Modules ▪ 120/240V, 60W Power Supply ▪ 10' DC Extension Power Cord ▪ 2 - Profusion Connecting Kits ▪ Profusion Hanging Hardware Kit
UV-4000QB (4 Lamp Array)	Kit Includes
	<ul style="list-style-type: none"> ▪ 4 - Glo-Black Profusion LED UV-A Modules ▪ 120/240V, 120W Power Supply ▪ 10' DC Extension Power Cord ▪ 3 - Profusion Connecting Kits ▪ Profusion Hanging Hardware Kit
UV-4000PB (5 Lamp Array)	Kit Includes
 <p data-bbox="485 1474 699 1498">* Sample set-up shown</p>	<ul style="list-style-type: none"> ▪ 5 - Glo-Black Profusion LED UV-A Modules* ▪ 120/240V, 120W Power Supply ▪ 10' DC Extension Power Cord ▪ 4 - Profusion Connecting Kits ▪ Profusion Hanging Hardware Kit

PROFUSION ACCESSORIES

Part #	Description
UV-1100	Lamp Mounting Arm
UV-2007	10' DC Extension Power Cord
UV-2023	120/240V, 60W Power Supply
UV-2030	Profusion Joining Plate & Connecting Wire Kit
UV-2031	120/240V, 120W Power Supply (4-7 Profusion Modules)
UV-4000W	Profusion Casper, White Light Module
UV-4010	Swivel Mount Lamp Holder
UV-4015	Profusion Hanging Hardware Kit
UV-4020	Profusion Shield Kit
UV-4200	Profusion Switch Block (includes power supply)
UV-7100	25W Wall Mount Power Supply

PROFUSION HIGHLIGHT: VERSATILITY



Seven Glo-Black Profusion LED UV-A modules shown linked together with Profusion joining plates & connecting wires, and hanging hardware

PROFUSION XW

LED UV-A LAMP



PROFUSION XW CHARACTERISTICS

<i>Performance Attributes</i>	<i>Parameters</i>
Maximum Irradiance (at 24 in/38cm)	10000 $\mu\text{W}/\text{cm}^2$
Peak Wavelength	365 \pm 5 nm
Typical Irradiated Area (profile at 15 in)	Circular Spot 20" Diameter > 1000 $\mu\text{W cm}^2$ (347-382 nm)
Emission Spectrum	
Full Width at Half Maximum (FWHM)	\leq 15 nm
Longest Wavelength at Half Max (LWHM)	\leq 377 nm
Full width at 10% Maximum	\leq 30 nm (\pm 15)
Excitation Irradiance (347-382 nm)	> 7000 $\mu\text{W}/\text{cm}^2$
Wavelength Drift (at 70° F ambient)	\leq 1 nm
Typical Visible Emission (390-800 nm)	
	ASTM E3022 \leq 2 ft candles at 24 in
	RRES 90061 \leq 20 lux at 24 in

<i>Physical Attributes</i>	<i>Parameters</i>
Operating Environment	32 - 115° F
Maximum Housing Temperature (at 70° F ambient)	92 ° F
Lamp Cord Length	10 ft Standard
Power Supply Cord Length	10 ft
Weight	5.8 lb
Power in	100-240V AC / 50 - 60Hz
Specification Compliance	ASTM E3022, RRES 90061, ISO 3059, Airbus AITM 6-1001

Emission Spectrum measured at Stabilization Temperature

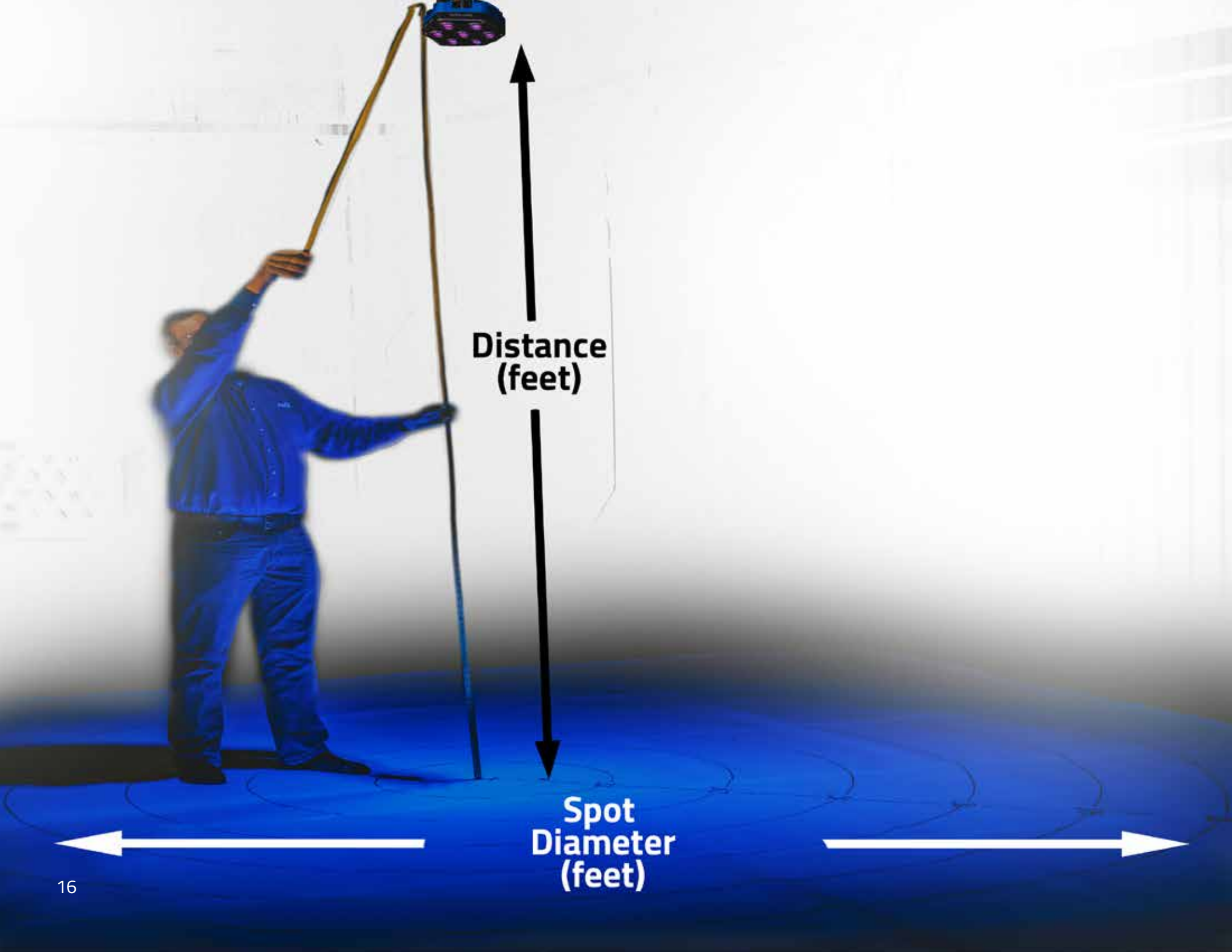

**Distance
(feet)**

**Spot
Diameter
(feet)**



> 1000 $\mu\text{W}/\text{cm}^2$ at
4 feet away



> 300 $\mu\text{W}/\text{cm}^2$ at
4 feet away



> 100 $\mu\text{W}/\text{cm}^2$ at
4 feet away



> 300 $\mu\text{W}/\text{cm}^2$ at
9 feet away



> 100 $\mu\text{W}/\text{cm}^2$ at
9 feet away

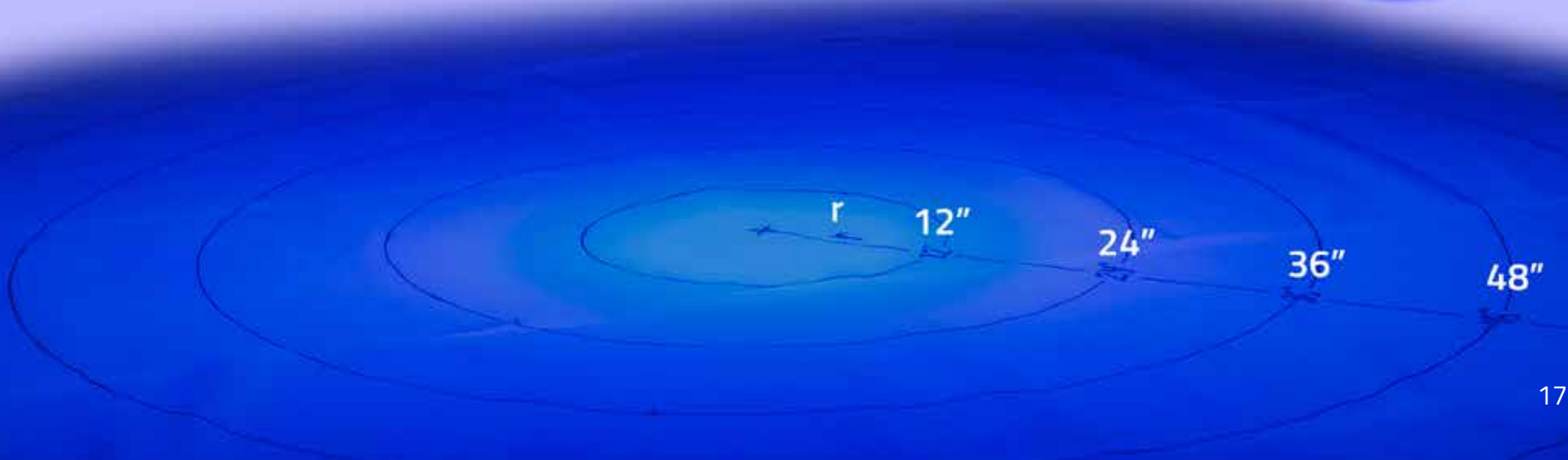

PROFUSION XW PERFORMANCE DATA

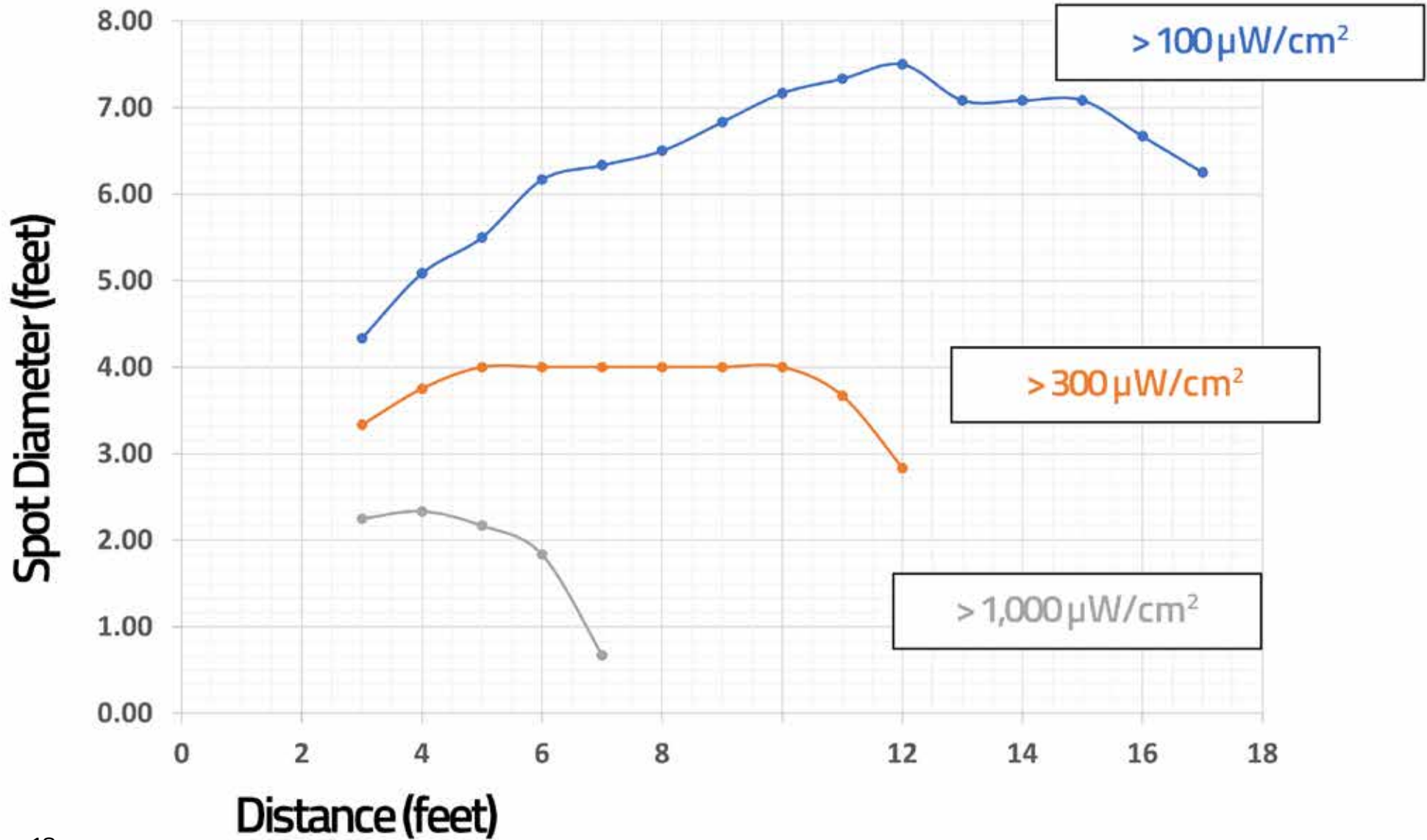

PROFUSION XW: HOW TO BUY

UV-4700	Kit Includes
	<ul style="list-style-type: none"> ▪ Glo-Black Profusion XW Lamp ▪ 120/240V, 120W Power Supply ▪ 10' DC Extension Power Cord ▪ Hanging Hardware ▪ Swivel Mount Lamp Holder ▪ Tool Control System ▪ Safety glasses

PROFUSION XW ACCESSORIES

Part #	Description
UV-1100	Lamp Mounting Arm
UV-2031	120/240V, 120W Power Supply
UV-4010	Swivel Mount Lamp Holder
UV-4015	Profusion Hanging Hardware Kit
TRM-100	Tripod Kit, Adjustable Tripod with ball head, 12" - 62" height, 27lb capacity, ARCA adapter

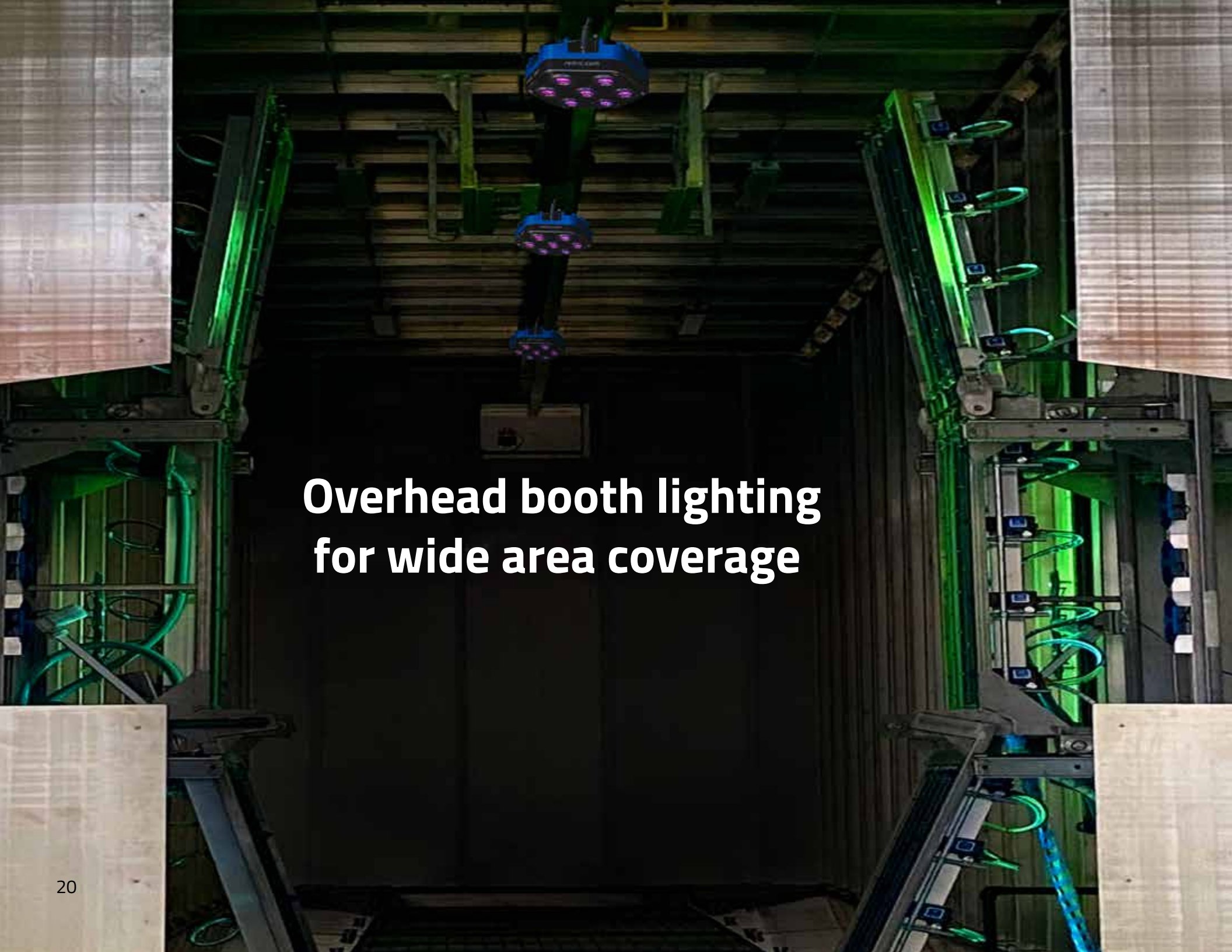
The image shows the interior of a technical booth with a dark, wood-paneled ceiling. Three blue, multi-lens overhead light fixtures are suspended from the ceiling. The walls are lined with metal racks containing various cables and equipment. The overall lighting is dim, with the primary light source being the overhead fixtures. The text "Overhead booth lighting for wide area coverage" is centered in white.

**Overhead booth lighting
for wide area coverage**

PROFUSION XW

REL's Profusion XW IP68 rated overhead lamp builds on the classic Profusion to offer 7x higher output and wider coverage area in a lamp head of equal frontal area.

Massive amounts of UV-A wavelength emission in a small package! The Profusion XW is the perfect lamp for larger FPI and MPI non-destructive testing environments. The design of this package was demanded by aerospace and space companies that produce parts that are over 100 feet in length. Integration of heat sinks and cooling are a foundational part of this lamp's design.



1. UV-4700 lamp back showing dimensions, fan, and the military grade aluminum machined finned housing for optimal cooling.
2. Glo-Black Profusion XW survive the toughest, wettest, and most severe work environments.
3. UV-A output is $> 300\mu\text{W}/\text{cm}^2$ at 9ft away with a spot size of 48".
4. Profusion XW shown with Profusion Hanging Hardware Kit (UV-4015).

Profusion XW Certifications & Compliances

- Tested & Complies with ASTM E3022 STANDARD
- Tested & Complies with ROLLS-ROYCE RRES 90061 REQUIREMENTS
- Tested & Complies with AIRBUS AITM 6-1001
- Meets Specifications ISO 3059
- IP68 Rated – Dust Sealed & Waterproofed
- 2 Year Warranty Guarantee
- Serialized Certificate of Conformance

Profusion XW Features and Benefits

- 7x the intensity of the classic Profusion Lamp
- High intensity UV-A light emitters for wide coverage areas
- 100% continuous duty at full output
- Engineered fin housing allows for maximum heat transfer in the harshest environments
- Built-in static-electric discharge unit safety feature
- AC: 120/240V
- Individual lamp dimensions: 8" H x 7.25" W



Profusion XW Modules being anodized on REL's in-house processing line.

C4 NOMAD LED UV-A LAMP





POWERED BY
M18 REDLITHIUM™

Directions For Use:

1. Remove from Tool Control System.
2. Drop
3. Kick
4. Use

*Note: Steps 2-4 can be performed in any order!

C4 NOMAD & NOMAD-GO LED UV-A CHARACTERISTICS

<i>Performance Attributes</i>	<i>Parameters</i>
Maximum Irradiance (at 15 in/38cm)	5000 $\mu\text{W}/\text{cm}^2$
Peak Wavelength	365 \pm 5 nm
Irradiance at Peak Wavelength (at 15 in)	> 200 $\mu\text{W}/\text{cm}^2$
Typical Irradiated Area (profile at 15 in)	Circular Spot 10" Diameter > 1000 $\mu\text{W cm}^2$ (347-382 nm)
Emission Spectrum	
Full Width at Half Maximum (FWHM)	\leq 15 nm
Longest Wavelength at Half Max (LWHM)	\leq 380 nm
Full width at 10% Maximum	\leq 30 nm (\pm 15)
Excitation Irradiance (347-382 nm)	> 2500 $\mu\text{W}/\text{cm}^2$
Wavelength Drift (at 70° F ambient)	\leq 3 nm
Working Distances	
	ASTM E3022 Minimum WD \leq 5 in
	RRES 90061 Minimum WD = 12 in
	Maximum WD = 23"
Typical Visible Emission (390-800 nm)	
	ASTM E3022 \leq 2 ft candles
	RRES 90061 \leq 20 lux at 15 in

<i>Physical Attributes</i>	<i>Parameters</i>
Operating Environment	32 - 120° F
Maximum Housing Temperature (at 70° F ambient)	116° F
Power Supply Cord Length	18 V Lithium Ion Battery
Weight	3.2 lb
Approximate run time/per battery	2.5 hrs
Specification Compliance	ASTM E3022, RRES 90061, ISO 3059, Airbus AITM 6-1001

C4 NOMAD & C4 NOMAD-GO BEAM PROFILE

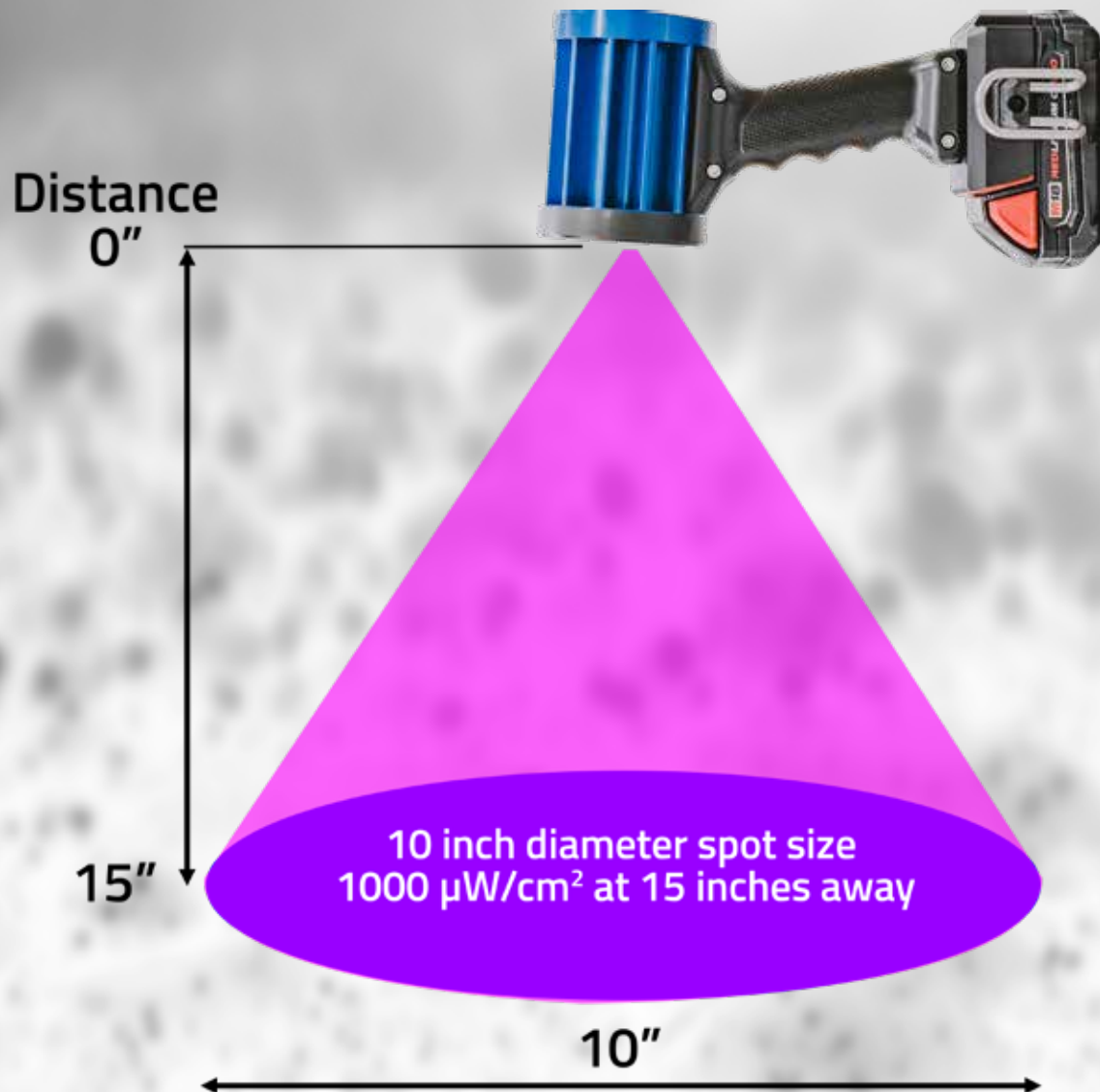

REL'S Nomad cordless UV-A inspection lamps are powered by M18.



C4 NOMAD

The C4 Nomad is powered by the versatile Milwaukee M18 battery pack, allowing the operator to choose the optimal amp/hour battery best suited for their continuous use application. The C4 Nomad is designed for all intensity requirements of Fluorescent Penetrant Inspection (FPI) and Magnetic Particle Inspection (MPI). REL's C4 Nomad inspection lamps contain high flux UV-A and white light LED emitters with built-in static-electric discharge circuits.

The C4 Nomad provides a 10-inch diameter of UV-A intensity $>1000 \mu\text{W}/\text{cm}^2$ at 15 inches. The integral filter in the UV-A emitter limits the visible light to 20 lux (1.86 foot-candles) at 15 inches, and 5 lux (0.47 foot-candles) at 36 inches. The lamp performs in all environments regardless of ambient conditions. The C4 Nomad LED UV-A will survive the toughest, wettest, and most severe work environments on the planet!



1. C4 Nomad shown in use on a REL FPI line.
2. REL M18 product integration feature.
3. C4 Nomad lamp body run over by a 16,500 lb forklift!
4. C4 Nomad shown with REL's Spray Can Fixture (fits any REL hand-held lamp).

C4 Nomad & C4 Nomad-GO Certifications & Compliances

- Tested & Complies with ASTM E3022 STANDARD
- Tested & Complies with ROLLS-ROYCE RRES 90061 REQUIREMENTS
- Tested & Complies with AIRBUS AITM 6-1001
- Meets Specifications ISO 3059
- 2 Year Warranty Guarantee
- Serialized Certificate of Conformance

C4 Nomad & C4 Nomad-GO Features and Benefits

- Powered by Milwaukee RedLithium M18 battery pack system
- High output UV-A LED emitters with white light (Nomad-GO) emitter for darker inspection environments
- Easy to use controls with clear indicators for lamp on/off operation
- Built in static-electric discharge unit safety feature
- Individual lamp dimensions: 10.6" H x 3.0" W x 4.6" D
- Individual lamp weight: 3.2 lbs.
- Refurbishable
- Will not fall out of spec with Limiting Driver



REL's in-house anodizing process

BLUE DYE

RINSE

C4 NOMAD: 3 WAYS TO BUY

UV-2400	Kit Includes
 The image shows the UV-2400 kit components: a blue and black handheld UV-A lamp, a black 120V M18 battery charger, two M18 2-Amp hour batteries, a red and black tool control system, and a pair of safety glasses.	<ul style="list-style-type: none">▪ Glo-Black C4 Nomad LED UV-A Lamp▪ 120V M18 Battery Charger▪ Two M18 2-Amp hour batteries▪ Tool Control System▪ Safety glasses
UV-2400BT	Kit Includes
 The image shows the UV-2400BT kit components: a blue and black handheld UV-A lamp and a pair of safety glasses.	<ul style="list-style-type: none">▪ Glo-Black C4 Nomad LED UV-A Lamp (bare tool)▪ Safety glasses
470-00000	Kit Includes
 The image shows the 470-00000 kit components: a black carrying case containing various testing supplies.  <p><i>"The only complete mobile testing kit available to the fleet"</i></p>	<p>FPI Mobile Testing Nomad Kit: Type 1, Method C</p> <ul style="list-style-type: none">▪ C4 Nomad LED UV-A Lamp▪ 120V M18 Battery Charger▪ Two M18 2-Amp hour batteries▪ 1 can penetrant▪ 1 can developer▪ 2 cans cleaner▪ Tool Control System with foam that is cross-linked polyethylene, resistant to jet fuel and hydraulic fluid.▪ Safety glasses▪ NSN: 6850-01-676-2205

C4 NOMAD ACCESSORIES

Part #	Description
UV-1025	Tool Control System for Nomad Lamps
UV-1100	Lamp Mounting Arm
UV-2016	Domer & Ding Ring
470-00007	120V M18 Battery Charger
470-00008	M18 2-Amp hour Battery
UV-7000	Spray Can Fixture (Hands-Free Applicator)
UV-7400	SNAPSHOT-UV includes GoPro™ HERO9

ACCESSORY HIGHLIGHT

"REL, Inc. is an authorized Original Design Manufacturer (ODM) distributor of MILWAUKEE ELECTRIC TOOL CORPORATION."



C4 Nomad-GO & C4 Nomad shown integrated with M18 batteries.



C4 NOMAD-GO

LED UV-A LAMP + WHITE LIGHT





POWERED BY
M18 REDLITHIUM™

Directions For Use:

1. Remove from Tool Control System.
2. Drop
3. Kick
4. Use

*Note: Steps 2-4 can be performed in any order!

What do you get when you cross REL'S C4 Magnum-GO with Milwaukee powered portability?



C4 Nomad-GO

C4 NOMAD-GO

The C4 Nomad-GO is designed for all intensity requirements of Fluorescent Penetrant Inspection (FPI) and Magnetic Particle Inspection (MPI). REL's C4 Nomad-GO inspection lamps contain high flux UV-A and white light LED emitters with built-in static-electric discharge circuits. The C4 Nomad-GO provides a 10-inch diameter of UV-A intensity $>1000 \mu\text{W}/\text{cm}^2$ at 15 inches. The integral filter in the UV-A emitter limits the visible light to 20 lux (1.86 foot-candles) at 15 inches and 5 lux (0.47 foot-candles) at 36 inches.

The LED white light provides an intensity > 700 -foot candles at 15 inches. The lamp's electrical components are sealed and passively cooled within an engineered finned housing manufactured from military-grade aluminum. The lamp performs in all environments regardless of ambient conditions. The C4 Nomad-GO LED UV-A with white light will survive the toughest, wettest, and most severe work environments on the planet!



1. C4 Nomad-GO in use on a REL TAM Panel.
2. C4 Nomad-GO in use with REL's Snapshot-UV.
3. C4 Nomad-GO lamp body run over by a 16,500 lb forklift!
4. REL Lamps survive the toughest, wettest, and most severe work environments.

C4 NOMAD-GO: 3 WAYS TO BUY

UV-3400	Kit Includes
	<ul style="list-style-type: none">▪ Glo-Black C4 Nomad-GO LED UV-A Lamp▪ 120V M18 Battery Charger▪ Two M18 2-Amp hour batteries▪ Tool Control System▪ Safety glasses
UV-3400BT	Kit Includes
	<ul style="list-style-type: none">▪ Glo-Black C4 Nomad LED UV-A Lamp (bare tool)▪ Safety glasses
470-10000	Kit Includes
 	<p>FPI Mobile Testing Nomad-GO Kit: Type 1, Method C</p> <ul style="list-style-type: none">▪ C4 Nomad-GO LED UV-A Lamp▪ 120V M18 Battery Charger▪ Two M18 2-Amp hour batteries▪ 1 can penetrant▪ 1 can developer▪ 2 cans cleaner▪ Tool Control System with foam that is cross-linked polyethylene, resistant to jet fuel and hydraulic fluid.▪ Safety glasses

C4 NOMAD-GO ACCESSORIES

Part #	Description
UV-1025	Tool Control System for Nomad Lamps
UV-1100	Lamp Mounting Arm
UV-2016	Domer & Ding Ring
470-00007	120V M18 Battery Charger
470-00008	M18 2-Amp hour Battery
UV-7000	Spray Can Fixture (Hands-Free Applicator)
UV-7400	SNAPSHOT-UV includes GoPro™ HERO9

ACCESSORY HIGHLIGHT

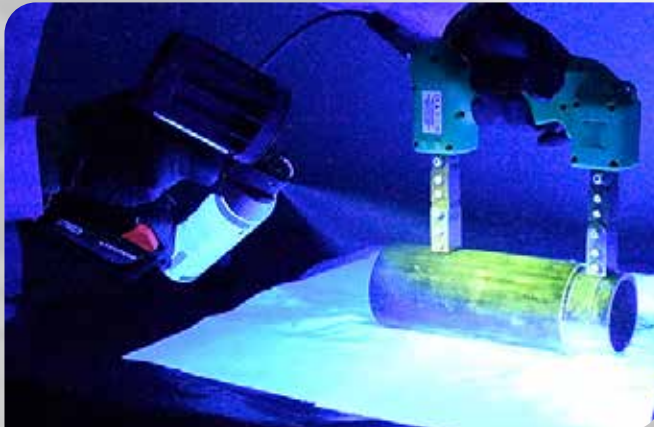

C4 Nomad-GO shown with Spray Can Fixture.

UV-7000

Spray Can Fixture

NOMAD-ASCENT

LED UV-A LAMP



Hands-Free / Cord-Free UV Power



Directions For Use:

1. Remove from Tool Control System.
2. Drop
3. Kick
4. Use

*Note: Steps 2-4 can be performed in any order!

NOMAD-ASCENT & NOMAD-ECLIPSE LED UV-A CHARACTERISTICS

<i>Performance Attributes</i>	<i>Parameters</i>
Maximum Irradiance (at 15 in/38cm)	2000 $\mu\text{W}/\text{cm}^2$
Peak Wavelength	365 \pm 5 nm
Irradiance at Peak Wavelength (at 15 in)	> 100 $\mu\text{W}/\text{cm}^2$
Typical Irradiated Area (profile at 15 in)	Circular Spot 8" Diameter > 1000 $\mu\text{W cm}^2$ (347-382 nm)
Emission Spectrum	
Full Width at Half Maximum (FWHM)	\leq 15 nm
Longest Wavelength at Half Max (LWHM)	\leq 377 nm
Full width at 10% Maximum	\leq 30 nm (\pm 15)
Excitation Irradiance (347-382 nm)	> 1200 $\mu\text{W}/\text{cm}^2$
Wavelength Drift (at 70° F ambient)	\leq 3 nm
Working Distances	
	ASTM E3022 Minimum WD \leq 5 in
	RRES 90061 Minimum WD = 8 in
	Maximum WD = 16"
Typical Visible Emission (390-800 nm)	
	ASTM E3022 \leq 2 ft candles
	RRES 90061 \leq 20 lux at 15 in



<i>Physical Attributes</i>	<i>Parameters</i>
Operating Environment	32 - 85° F
Maximum Housing Temperature (at 70° F ambient)	140° F
Power Supply	4 V Lithium Ion Battery
Weight	.5 lb
Approximate run time/per battery	1.6 hrs
Specification Compliance	ASTM E3022, RRES 90061, ISO 3059, Airbus AITM 6-1001

Emission Spectrum measured at Stabilization Temperature

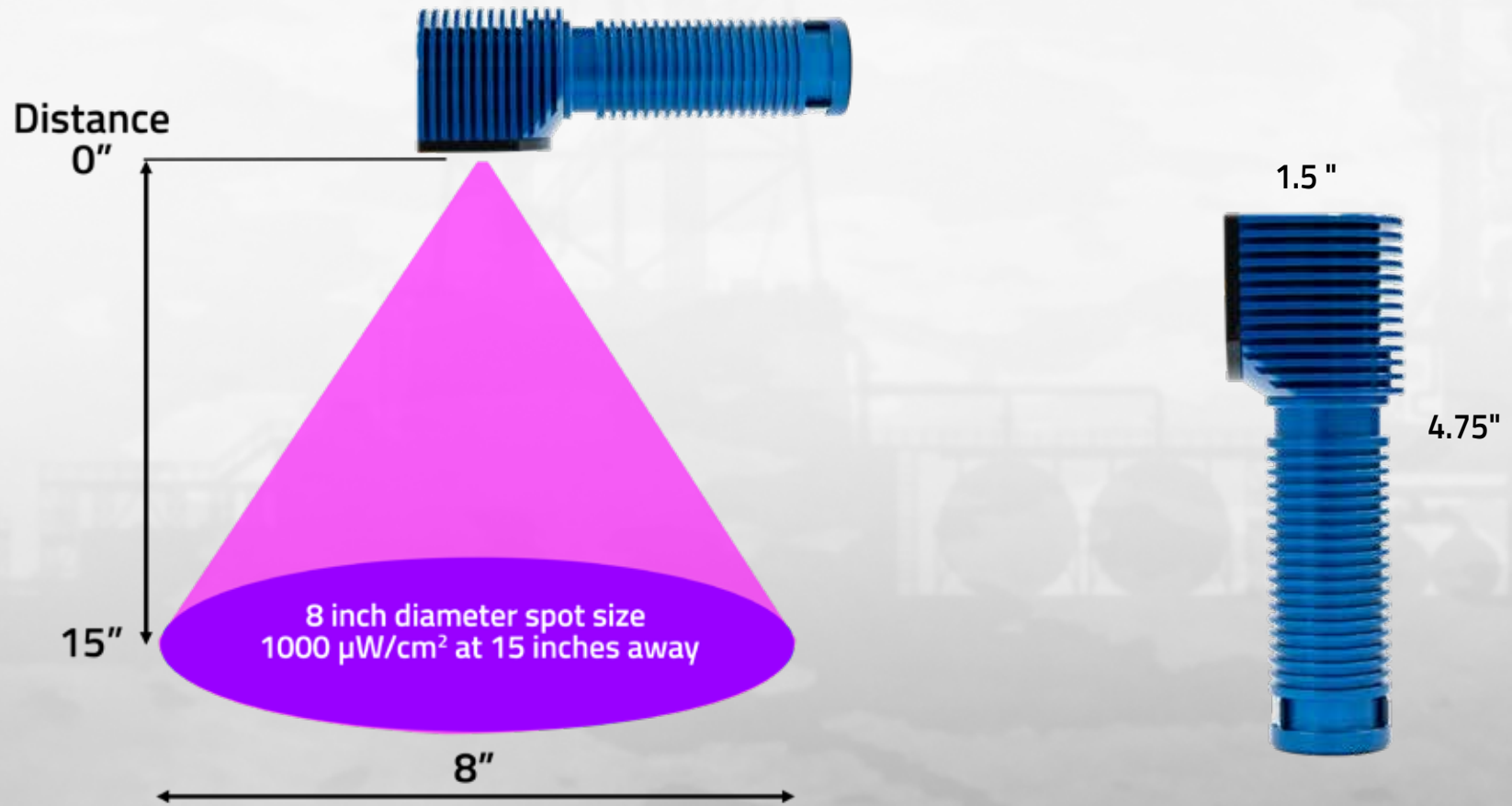
NOMAD-ASCENT & NOMAD-ECLIPSE BEAM PROFILE



NOMAD ASCENT & NOMAD ECLIPSE: HOW TO BUY

UV-5400	Kit Includes
	<ul style="list-style-type: none"> ▪ Nomad-Ascent LED UV-A Lamp ▪ 4 - Batteries ▪ 2 - USB chargers ▪ Headband ▪ Pocket clip ▪ Tool Control System ▪ Safety glasses
UV-6400	Kit Includes
	<ul style="list-style-type: none"> ▪ Nomad-Eclipse LED UV-A Lamp ▪ 4 - Batteries ▪ 2 - USB chargers ▪ Headband ▪ Pocket clip ▪ Tool Control System ▪ Safety glasses

ASCENT & ECLIPSE ACCESSORIES

Part #	Description
UV-5004	Head Band Mount Adapter only
UV-5420	Battery Pair for Nomad-Ascent and Nomad-Eclipse (set of 2 batteries with charging cable)
UV-5421	USB Charger for Nomad-Ascent and Nomad-Eclipse batteries
UV-5422	8-Place Battery Charger
UV-5424	Head Band for Nomad-Ascent and Nomad-Eclipse
UV-5425	Belt Clip for Nomad-Ascent and Nomad-Eclipse

NOMAD-ASCENT

REL Glo-Black Nomad-Ascent: Brings mobility to indications discovered in the FPI process.

The Nomad-Ascent is the highest power density lamp in the UV-A inspection market. This lamp delivers a powerful uniform beam pattern from a compact rugged machined housing of military grade aluminum. The Nomad-Ascent features a solid state switch along with fluoroelastomer sealed interfaces to deliver a punch way above its weight class.



1. 3D printed, infinite variable angle-of-focus mount.
2. Hand-held comfort with snap on pocket clip, or utilize its magnetic base by sticking it to any ferrous metal surface.
3. Threaded brass ring fastens replaceable viton switch material.
4. Kit includes: Lamp with magnetic base, 4 Batteries with 2 USB Chargers, Headband, Pocket clip, Tool Control System.

Nomad-Ascent & Nomad-Eclipse Certifications & Compliances

- Tested & Complies with ASTM E3022 STANDARD
- Tested & Complies with ROLLS-ROYCE RRES 90061 REQUIREMENTS
- Tested & Complies with AIRBUS AITM 6-1001
- Meets Specifications ISO 3059
- IP67 Rated – Dust Sealed & Waterproofed
- 5 Year Warranty Guarantee
- Serialized Certificate of Conformance

Nomad-Ascent & Nomad-Eclipse Features and Benefits

- 12-inch diameter spot above 1000 $\mu\text{W}/\text{cm}^2$ at startup
- 1.5 + hour run time with each 5000 mAh li-ion battery
- Quad-lead thread for quick single turn battery removal
- IP67 Rated (Tested in Carrier Fluid!)
- Lightweight - 7 ounces
- Magnetic base with 1/4-20 socket for fixed mounts
- Hard hat mountable
- Pocket clip



Nomad-Ascent & Nomad-Eclipse lamps shown in REL's in-house anodizing process.

NOMAD-ECLIPSE

LED UV-A LAMP + WHITE LIGHT



Compact / Cord-Free UV Power



Directions For Use:

1. Remove from Tool Control System.
2. Drop
3. Kick
4. Use

*Note: Steps 2-4 can be performed in any order!

REL lamps made to survive -56° Fahrenheit!

Showing deep freeze portion
of performance testing.

Nomad-Eclipse

REL Glo-Black Nomad-Eclipse: Brings mobility to indications discovered in the FPI process.

The Nomad-Eclipse integrated with LED UV-A & White Light is the "GO" version of the Nomad-Ascent. The Nomad-Eclipse delivers the highest power density, with a powerful uniform beam pattern, from a compact rugged machined housing of military grade aluminum in the UV-A inspection market. The certified, hands-free, cord-free, waterproof Nomad-Eclipse with its industry leading 5-Year Warranty will change your perception of what is possible.



1. 3D printed, infinite variable angle-of-focus mount.
2. Hand-held comfort with snap on pocket clip, or utilize it's magnetic base by sticking it to any ferrous metal surface.
3. Threaded brass ring fastens replaceable viton switch material.
4. Kit includes: Lamp with magnetic base, 4 Batteries with 2 USB Chargers, Headband, Pocket clip, Tool Control System.

FPI MOBILE TESTING KIT

Part #	Description
470-00000	<p>FPI Mobile Testing Nomad Kit: Type 1, Method C</p> <ul style="list-style-type: none">▪ NSN: 6850-01-676-2205▪ C4 Nomad LED UV-A Lamp▪ 120V M18 Battery Charger▪ Two M18 2-Amp hour batteries▪ 1 can penetrant▪ 1 can developer▪ 2 cans cleaner▪ Tool Control System with foam that is cross-linked polyethylene, resistant to jet fuel and hydraulic fluid.▪ Safety glasses



**FPI MOBILE TESTING
NOMAD
TYPE 1, METHOD C
PART # 470-00000
CAGE CODE: 5DLA1
NSN: 6850-01-676-2205**

1. 120V CHARGER 470-00007
2. C4 NOMAD 470-UV-2400
3. 18V BATTERY 470-00008
4. 18V BATTERY 470-00008
5. 1 CAN PENETRANT 470-00006
6. 1 CAN DEVELOPER 470-00005
7. 1 CAN CLEANER 470-00004
8. 1 CAN CLEANER 470-00004

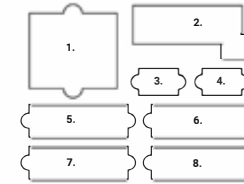

"The only complete mobile testing available to the fleet."

BOLT-ON POWER

Lift Point



Abrasion
Resistant



Prevent
Breakage



Durable

C4 MAGNUM

LED UV-A LAMP

NSN: 5980-01-671-7903





Directions For Use:

1. Remove from Tool Control System.
2. Drop
3. Kick
4. Use

*Note: Steps 2-4 can be performed in any order!

C4 MAGNUM & MAGNUM-GO LED UV-A CHARACTERISTICS

<i>Performance Attributes</i>	<i>Parameters</i>
Maximum Irradiance (at 15 in/38cm)	5000 $\mu\text{W}/\text{cm}^2$
Peak Wavelength	365 \pm 5 nm
Irradiance at Peak Wavelength (at 15 in)	> 200 $\mu\text{W}/\text{cm}^2$
Typical Irradiated Area (profile at 15 in)	Circular Spot 10" Diameter > 1000 $\mu\text{W cm}^2$ (347-382 nm)
Emission Spectrum	
Full Width at Half Maximum (FWHM)	\leq 15 nm
Longest Wavelength at Half Max (LWHM)	\leq 377 nm
Full width at 10% Maximum	\leq 30 nm (\pm 15)
Excitation Irradiance (347-382 nm)	> 2500 $\mu\text{W}/\text{cm}^2$
Wavelength Drift (at 70° F ambient)	\leq 3 nm
Working Distances	
ASTM E3022	Minimum WD \leq 5 in
RRES 90061	Minimum WD = 12 in Maximum WD = 23"
Typical Visible Emission (390-800 nm)	
ASTM E3022	\leq 2 ft candles
RRES 90061	\leq 20 lux at 15 in

<i>Physical Attributes</i>	<i>Parameters</i>
Operating Environment	32 - 120° F
Maximum Housing Temperature (at 70° F ambient)	116° F
Lamp Cord Length	10 ft (Standard)
Power Supply Cord Length	6 ft
Weight	1.7 lb
Power in	100-240V AC / 50 - 60Hz < 1.2A
Specification Compliance	ASTM E3022, RRES 90061, ISO 3059, Airbus AITM 6-1001

C4 MAGNUM & MAGNUM-GO BEAM PROFILE



REL's C4 Magnum corded inspection lamps utilizes the latest UV-A LED technology for non-destructive testing.



**Shot with 4 rounds
from a .45 ACP!**

C4 MAGNUM

The C4 Magnum contains a single high flux LED UV emitter that has a built in static-electric discharge circuit to allow the light to perform in all environments regardless of ambient conditions. Designed for Fluorescent Penetrant Inspection (FPI) and Magnetic Particle Inspection (MPI), the C4 Magnum provides a 10-inch diameter of UV-A intensity above 1000 $\mu\text{W}/\text{cm}^2$ at 15 inches. The integral filter in the C4 Magnum limits the visible light to 20 lux at 15 inches and 5 lux at 36 inches. Each lamp is sealed and cooled with an engineered finned housing manufactured from a military grade aluminum. The IP67 rated housing allows the lamp to perform in all environments regardless of ambient conditions. The C4 Magnum will survive the toughest, wettest, and most severe work environments on the planet!

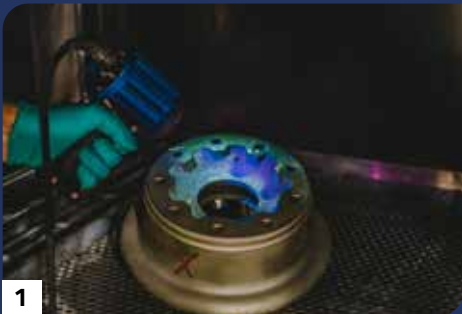

1



2



3



4

1. C4 Magnum shown in use in REL's human-driven Model I2C FPI line.
2. Bolt-on Power Cord for Magnum
3. C4 Magnum IP67 rated allows performance in all environments regardless of ambient conditions.
4. C4 Magnum run over by a 16,500 lb forklift!

C4 Magnum & C4 Magnum-GO Certifications & Compliances



- Tested & Complies with ASTM E3022 STANDARD
- Tested & Complies with ROLLS-ROYCE RRES 90061 REQUIREMENTS
- Tested & Complies with AIRBUS AITM 6-1001
- Meets Specifications ISO 3059
- IP67 Rated – Dust Sealed & Waterproofed
- 2 Year Warranty Guarantee
- Serialized Certificate of Conformance

C4 Magnum & C4 Magnum-GO Features and Benefits

- High output UV-A LED emitters with white light (Magnum-GO) emitter for darker inspection environments
- NSN: 5980-01-671-7903 (UV-2000)
- Tested to work as hard as you do
- Engineered fin housing allows for maximum heat transfer in the harshest environments.
- Easy to use controls with clear indicators for lamp on/off operation
- Built-in static-electric discharge unit safety feature
- AC Power: 120/240V
- Individual lamp dimensions: 7.6" H x 3.0" W x 4.1" D
- Individual lamp weight: 1.7 lbs.
- Refurbishable
- Bolt-on Power Cord



C4 MAGNUM: 3 WAYS TO BUY

UV-2000	Kit Includes
	<ul style="list-style-type: none">▪ Glo-Black C4 Magnum LED UV-A Lamp▪ Bolt-on Power Cord for Magnum▪ 120/240V, 60W Power Supply▪ Tool Control System▪ Safety glasses▪ NSN: 5980-01-671-7903
UV-2000NC	Kit Includes
	<ul style="list-style-type: none">▪ Glo-Black C4 Magnum LED UV-A Lamp▪ Bolt-on Power Cord for Magnum▪ 120/240V, 60W Power Supply▪ Safety glasses
UV-2000LM	Kit Includes
	<ul style="list-style-type: none">▪ Glo-Black C4 Magnum LED UV-A Lamp, Legacy Model▪ 10' DC Extension Power Cord▪ 25W Wall Mounted Power Supply▪ Safety glasses

C4 MAGNUM ACCESSORIES

Part #	Description
UV-1000	Bench Adapter/Lamp Holder
UV-1020	Tool Control System for Magnum Lamps
UV-1100	Mounting Arm
UV-2007	10' DC Extension Power Cord
UV-2014	Bolt-on Power Cord for Magnum
UV-2016	Domer & Ding Ring
UV-2023	120/240V, 60W Power Supply
UV-7000	Spray Can Fixture
UV-7100	25W Wall Mount Power Supply
UV-7400	Snapshot-UV (Lamp Mounted GoPro™ HERO9)

ACCESSORY HIGHLIGHT



BOLT ON POWER

A power cord that matches the toughness of our LED UV-A Lamps.



Abrasion
Resistant



Durable



Prevent
Breakage



Superior
Strength

C4 MAGNUM-GO

LED UV-A LAMP + White Light





Directions For Use:

1. Remove from Tool Control System.
2. Drop
3. Kick
4. Use

*Note: Steps 2-4 can be performed in any order!

The REL C4 Magnum-GO (Gas and Oil) corded LED UV-A Lamp integrates both UV-A and white light emitters for critical versatility in darker inspection environments.



C4 MAGNUM-GO

The C4 Magnum-GO is designed for all intensity requirements of Fluorescent Penetrant Inspection (FPI) and Magnetic Particle Inspection (MPI). REL's C4 Magnum-GO inspection lamps contain high flux UV-A and white light LED emitters with built-in static-electric discharge circuits. The C4 Magnum-GO provides a 10-inch diameter of UV-A intensity $> 1000 \mu\text{W}/\text{cm}^2$ at 15 inches. The integral filter in the UV-A emitter limits the visible light to 20 lux (1.86 foot-candles) at 15 inches and 5 lux (0.47 foot-candles) at 36 inches. The LED white light provides an intensity > 700 -foot candles at 15 inches. The lamp's electrical components are IP67 sealed and passively cooled within an engineered finned housing manufactured from military-grade aluminum. The lamp performs in all environments regardless of ambient conditions. The C4 Magnum-GO LED UV-A with white light will survive the toughest, wettest, and most severe work environments on the planet!



1. C4 Magnum-GO in use.
2. C4 Magnum-GO front shown with both LED UV-A and white light.
3. C4 Magnum-GO run over by a 16,500 lb forklift! And it still works!
4. The IP67 rating allows performance in all environments.

C4 MAGNUM-GO: 3 WAYS TO BUY

UV-3000	Kit Includes
 The UV-3000 kit includes a blue and black handheld UV-A lamp, a black carrying case, a power supply unit, a power cord, and safety glasses.	<ul style="list-style-type: none">▪ Glo-Black C4 Magnum-GO LED UV-A Lamp▪ Bolt-on Power Cord for Magnum-GO▪ 120/240V, 60W Power Supply▪ Tool Control System▪ Safety glasses
 The UV-3000NC kit includes a blue and black handheld UV-A lamp, a power supply unit, a power cord, and safety glasses.	<ul style="list-style-type: none">▪ Glo-Black C4 Magnum-GO LED UV-A Lamp▪ Bolt-on Power Cord for Magnum-GO▪ 120/240V, 60W Power Supply▪ Safety glasses
 The UV-3000LM kit includes a blue and black handheld UV-A lamp, a power supply unit, a power cord, and safety glasses.	<ul style="list-style-type: none">▪ Glo-Black C4 Magnum-GO LED UV-A Lamp, Legacy Model▪ 10' DC Extension Power Cord▪ 25W Wall Mounted Power Supply▪ Safety glasses

C4 MAGNUM-GO ACCESSORIES

Part #	Description
UV-1000	Bench Adapter/Lamp Holder
UV-1020	Tool Control System for Magnum Lamps
UV-1100	Mounting Arm
UV-2007	10' DC Extension Power Cord
UV-2015	Bolt-on Power Cord for Magnum-GO
UV-2016	Domer & Ding Ring
UV-2023	120/240V, 60W Power Supply
UV-7000	Spray Can Fixture
UV-7100	25W Wall Mount Power Supply
UV-7400	Snapshot-UV (Lamp Mounted GoPro™ HERO9)

ACCESSORY HIGHLIGHT

BOLT-ON POWER

A power cord that matches the toughness of our LED UV-A Lamps.



Abrasion
Resistant



Durable



Prevent
Breakage



Superior
Strength



LIQUID STYLUS

LED UV-A LAMP



LIQUID STYLUS BEAM PROFILE

$\text{Ø } 4'' > 1000 \mu\text{W}/\text{cm}^2$ at 15 inches away

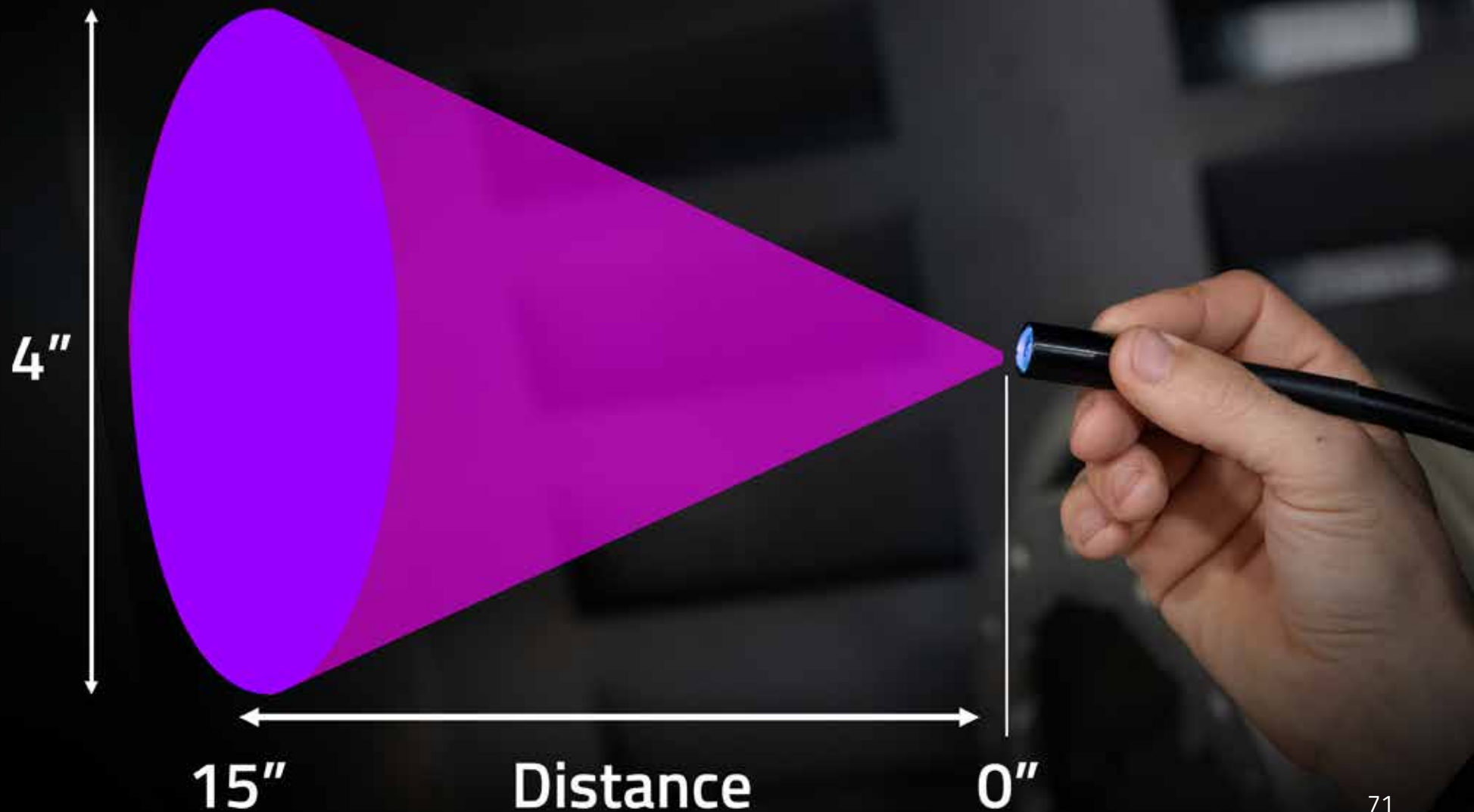

LIQUID STYLUS LED UV-A CHARACTERISTICS

<i>Performance Attributes</i>	<i>Parameters</i>
Maximum Irradiance (at 15 in/38cm)	2000 $\mu\text{W}/\text{cm}^2$
Peak Wavelength	365 \pm 5 nm
Irradiance at Peak Wavelength (at 15 in)	> 100 $\mu\text{W}/\text{cm}^2$
Typical Irradiated Area (profile at 15 in)	Circular Spot 4" Diameter > 1000 $\mu\text{W cm}^2$ (347-382 nm)
Emission Spectrum	
Full Width at Half Maximum (FWHM)	\leq 15 nm
Longest Wavelength at Half Max (LWHM)	\leq 377 nm
Full width at 10% Maximum	\leq 30 nm (\pm 15)
Excitation Irradiance (347-382 nm)	> 1200 $\mu\text{W}/\text{cm}^2$
Wavelength Drift (at 70° F ambient)	\leq 3 nm
Working Distances	
ASTM E3022	Minimum WD \leq 4 in
RRES 90061	Minimum WD = 8 in
	Maximum WD = 16"
Typical Visible Emission (390-800 nm)	
ASTM E3022	\leq 2 ft candles
RRES 90061	\leq 20 lux at 15 in

<i>Physical Attributes</i>	<i>Parameters</i>
Operating Environment	32 - 100° F
Maximum Housing Temperature (at 70° F ambient)	116 ° F
Lamp Cord Length	10 ft Standard
Power Supply Cord Length	\approx 6 ft
Lamp body weight	1.8 lb
Stylus weight	2 oz
Power in	100-240V AC / 50 - 60Hz < 1.2A
Specification Compliance	ASTM E3022, RRES 90061, ISO 3059, Airbus AITM 6-1001

Use ergonomic elegance to solve the challenges of inspecting complex part geometries with our Liquid Stylus.



**Bolt-on
Power Cord**

2-Meter Light Guide

**Stylus
Holder**

Swivel Mount Lamp Holder

Magnetic base

LIQUID STYLUS: HOW TO BUY

UV-2100DH	Kit Includes
	<ul style="list-style-type: none"> ▪ Glo-Black Liquid Stylus LED UV-A Lamp ▪ 2-Meter Light Guide ▪ Bolt-on Power Cord for Magnum ▪ 120/240V, 60W Power Supply ▪ Swivel Mount Lamp Holder ▪ Tool Control System ▪ Safety glasses

LIQUID STYLUS ACCESSORIES

Part #	Description
UV-1020	Tool Control System for Magnum Lamps
UV-1100	Mounting Arm
UV-2007	10' DC Extension Power Cord
UV-2015	Bolt-on Power Cord for Magnum Lamps
UV-2023	120/240V, 60W Power Supply
UV-2120DH	2-Meter Light Guide
UV-7100	25W Wall Mount Power Supply

LIQUID STYLUS

The 2-meter length of the liquid light guide allows for the inspection of surface geometries with high depth-to-diameter ratios, while maintaining fingertip control of the 365nm LED UV-A lamp. These lamps were developed to address operator safety and the rigorous precision demands during the inspection of complex part geometries encountered in FPI and MPI inspections. Operator fatigue with the risk of carpal tunnel injuries can happen in a repetitive motion environment with non-natural wrist flexure. Utilizing a liquid lamp limits wrist forces to less than 2 oz. This allows the inspector to manipulate the powerful photon stream of UV-A radiation with the dexterity and pinpoint accuracy of a surgeon's scalpel.



1. Liquid Stylus shown in use on an aerospace part.
2. Liquid Stylus packaged in a Tool Control System.
3. 2-Meter Light Guide
4. Liquid Stylus used on a REL TAM Panel showing defect.

Liquid Stylus Certifications & Compliances

- Tested & Complies with ASTM E3022 STANDARD
- Tested & Complies with ROLLS-ROYCE RRES 90061 REQUIREMENTS
- Tested & Complies with AIRBUS AITM 6-1001
- Meets Specifications ISO 3059
- IP67 Rated – Dust Sealed & Waterproofed
- 2 Year Warranty Guarantee
- Serialized Certificate of Conformance

Liquid Stylus Features and Benefits

- Lightest compliant inspection lamp in the world
- Easy to use controls with clear indicators for lamp on/off operation
- 10mm diameter Liquid light source
- Maximize time on task with lightweight operation
- Reduce injuries in your inspection booth
- IP67 Rated

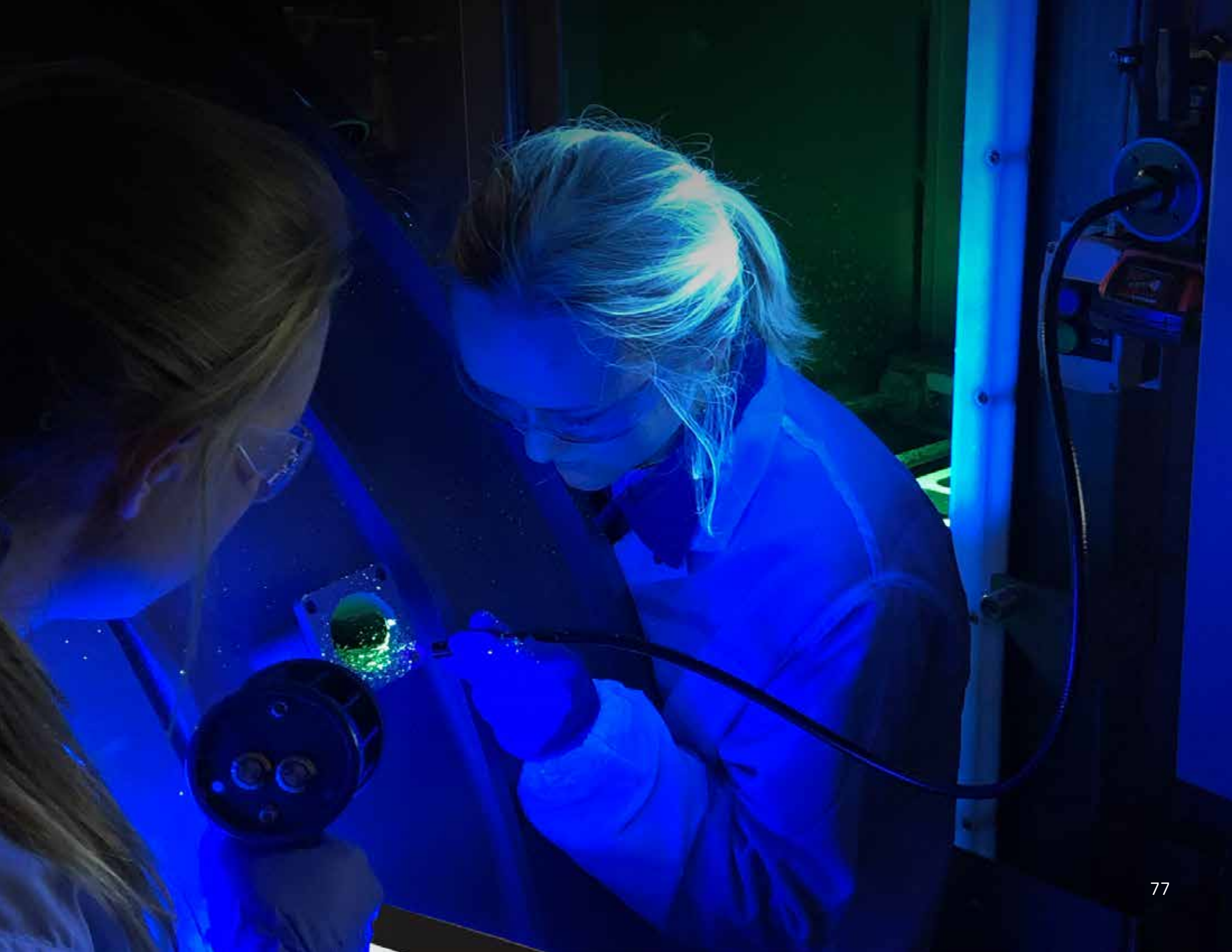

REL TAM PANEL

PRATT & WHITNEY APPROVED TAM 146040-1, 146040-2
HEXAVALENT CHROMIUM FREE

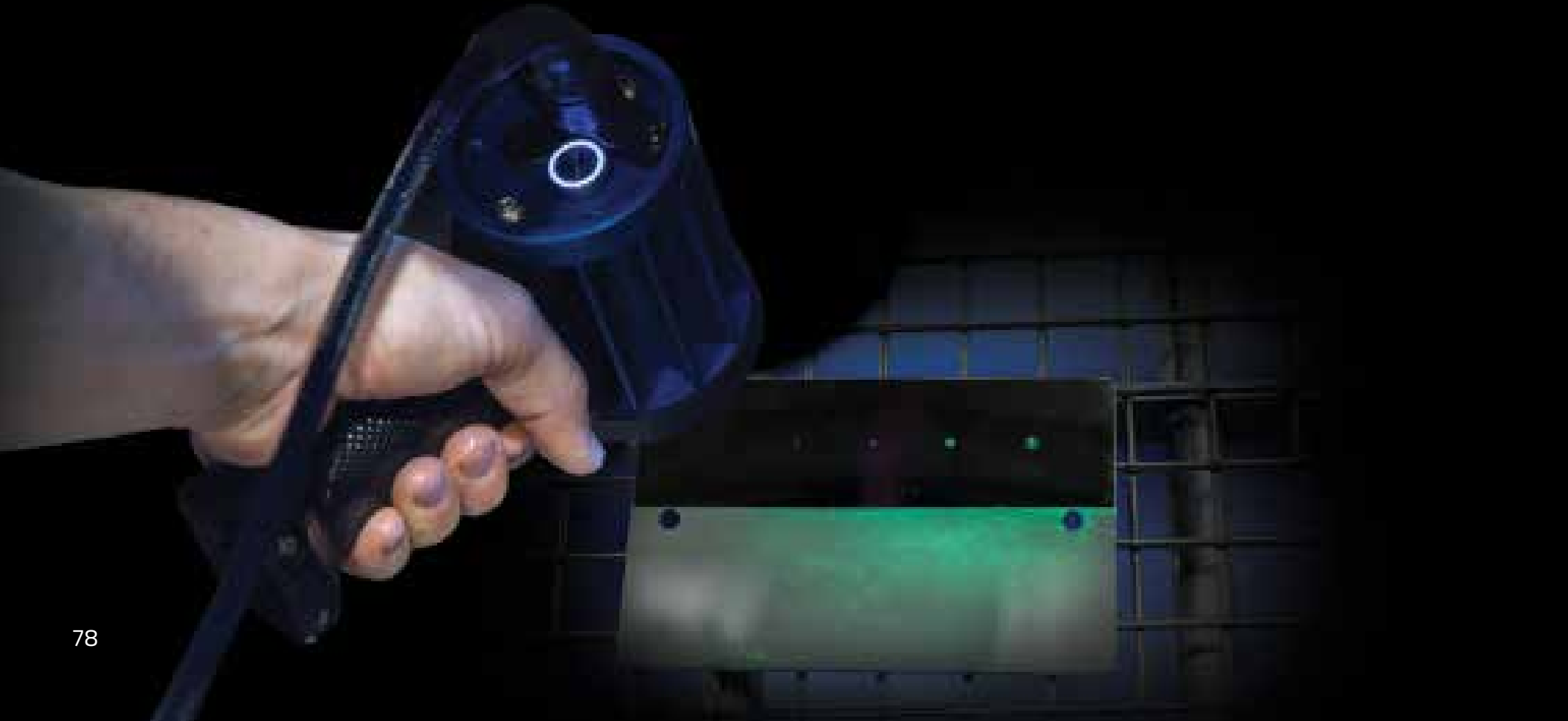

Pratt & Whitney Approved TAM 146040-1 (Mirror Finish Polished) & 146040-2 (Grit)

REL Designed Green 



Compliances met by REL TAM Panel plating: RoHS, REACH, WEEE, ELV, and Proposition 65.

Certification for GE Aviation Process Specification P3TF47

REL Certified 

REL, Inc. is an officially approved P&W Source Manufacturer. REL, Inc. certifies that the Fluorescent Penetrant Inspection REL TAM Panels meets the requirements as stated in TAM146040 Rev. R, ASTM E1417, MIL-STD-6866, TO 33B-1-1, NAVAIR 01-1A-16-1, TM 1-1500-335-23, Rolls-Royce, and GE Aviation Process Specification P3TF47. The REL TAM Panel has been manufactured and tested in accordance with the REL, Inc. procedure RWI-1105.

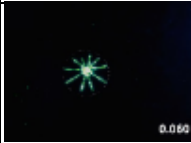
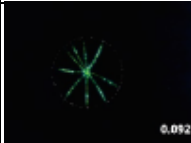
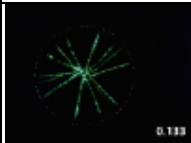
PENETRANT SYSTEM MONITORING PANEL DOCUMENTATION

SN# 23120500					
Crack Position	A	B	C	D	E
Photo of Defect					
Magnification Factor: 1 : 5.5					
Measured Size [Inch]	0.026	0.060	0.092	0.133	0.196
Specification [Inch]	0.015 - 0.031	0.046 - 0.062	0.075 - 0.093	0.125 - 0.171	0.180 - 0.250
Measured Size [mm]	0.66	1.52	2.34	3.38	4.98
Specification [mm]	0.38 - 0.79	1.17 - 1.57	1.91 - 2.36	3.18 - 4.34	4.57 - 6.35
Crack Depth	.0025" ± .0001"	63 µm ± 2.5µm			



REL TAM Panel - Single
(Part Number: 250-00104)

REL TAM Panel - Twin
(Part Number: 250-00103)



REL TAM Panel - Grit
(Part Number: 250-00105)

REL TAM Panel and Documentation included:

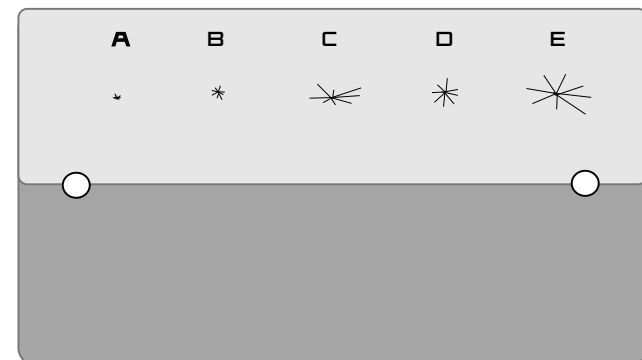
1. Case w/ panel certification,
2. Serialized crack size certification documents, including
3. 1:1 picture



REL TAM PANEL: HOW TO BUY

250-00103	Kit Includes
	<ul style="list-style-type: none">▪ REL Tam Panel – Twin (Polished)▪ Panel Certificate of Conformance (Sealed)▪ Serialized crack size certification document▪ 1:1 picture of manufactured defects▪ Tool Control System
250-00104	Kit Includes
	<ul style="list-style-type: none">▪ REL Tam Panel – Single (Polished)▪ Panel Certificate of Conformance (Sealed)▪ Serialized crack size certification document▪ 1:1 picture of manufactured defects▪ Tool Control System
250-00105	Kit Includes
	<ul style="list-style-type: none">▪ REL Tam Panel – Single (Grit)▪ Panel Certificate of Conformance (Sealed)▪ Serialized crack size certification document▪ 1:1 picture of manufactured defects▪ Tool Control System

REL TAM PANEL

REL, Inc. is an approved Pratt & Whitney Source Manufacturer of the FPI Test Panel: TAM146040 Rev. R. REL manufactures the P&W Testing and Monitoring (TAM) Panels to the exacting standards put forth in the specification without the inherent toxicity due to the application of hexavalent chromium. Deploying the prerequisite AISI 316 Stainless Steel, REL utilizes a proprietary, non-clogging, Nickel plating with specialized heat treatment to achieve the stated panel thickness and replicate the hardness specifications of AMS 2406, Hard Deposit Chromium Plating. REL's environmentally friendly, Hexavalent Chromium free TAM Panels comply with RoHS, REACH, WEEE, ELV, and Proposition 65.

REL offers Polished/Mirror Finish & Grit TAM Panels:

- 250-00104 REL TAM Panel - Single (Polished)
- 250-00103 REL TAM Panel - Twin (Polished)
- 250-00105 REL TAM Panel - Single (Grit)



1. REL TAM Panel Kit includes: TAM Panel (s), Panel Certification (with REL TAM Panel Processing Procedure, on back page), Panel Documentation with 1:1 picture, and Tool Control System.
2. REL TAM Panel - Single (Polished) shown.
3. 1:1 picture is featured on the serialized crack size certification document.
4. Tool Control System provided with each purchase.

NOMAD-DER

DIODE EMISSION RECORDER



POWERED BY
M18 REDLITHIUM



Showing grinding sparks testing.



Directions For Use:

1. Remove from Tool Control System.
2. Drop
3. Kick
4. Use

***Note: Steps 2-4 can be performed in any order!**

NOMAD-DER: HOW TO BUY

UV-7300	Kit Includes
	<ul style="list-style-type: none"> ▪ Nomad-DER ▪ 12V M18 Battery Charger ▪ Two M18 2-Amp hour batteries ▪ Tool Control System

UV-7300BT	Kit Includes
	<ul style="list-style-type: none"> ▪ Nomad-DER (light meter only)

NOMAD-DER ACCESSORIES

Part #	Description
TRM-025	Tripod with adjustable ball head, ARCA adapter

ACCESSORIES HIGHLIGHT



Nomad-DER fits with REL's C4 Nomad-GO LED UV-A Lamp Kit (UV-3400 w/ UV-7300)

NOMAD-DER

The new Nomad-DER, designed specifically for use with LED Emitters, is the next generation of light meters. The Nomad-DER contains an innovative and intuitive data recording application. Powered by REL's partnership with Milwaukee Tool, and the REDLITHIUM M18 Battery, the Nomad-DER with its rugged, military grade, machined aluminum housing is designed to survive the toughest work environments on planet earth.

- Blue 4 digit LED display for UV-A energy ($\mu\text{W}/\text{cm}^2$) 0-30,000 range
- White 4 digit LED display for visible light energy (foot candles) 0-1,500 range
- Sealed aluminum housing that integrates with M18 battery technology
- 1/4-20 threaded hole for mounting
- 50 hour run time with 2-Amp hour battery
- Connects to mobile or desktop via Wi-Fi to view and record date, serial #, UV-A, and foot-candle readings
- Internal memory can save 20,000+ data entries



1. Large LED readouts for visibility throughout your inspection area.
2. Powered by M18 REDLITHIUM technology.
3. Tripod (TRM-025) mounting capabilities for custom setups.
4. Large display glass makes cleaning dust and debris easy.

REL PRODUCT INTEGRATION

"REL, Inc. is an authorized Original Design Manufacturer (ODM) distributor of MILWAUKEE ELECTRIC TOOL CORPORATION."

C4 Nomad UV-2400



C4 Nomad-GO UV-3400



120 Volt M18 Battery Charger



Two M18 2-Amp hour Batteries included in kit

POWERED BY
M18 REDLITHIUM

TOOL CONTROL SYSTEMS

Eliminate workplace FOD (Foreign Object Debris)

UV-2000 Magnum
UV-3000 Magnum-GO



UV-5400 Nomad-Ascent
UV-6400 Nomad-Eclipse







UV-2400 Nomad
UV-3400 Nomad-GO







470-00000 FPI Mobile
Testing Nomad Kit











LED UV-A LAMP ACCESSORIES





UV-1000	Description
	Bench Adapter/Lamp Holder
UV-1020	Description
	Tool Control System for Magnum Lamps
UV-1025	Description
	Tool Control System for Nomad Lamps
UV-1100	Description
	Lamp Mounting Arm



UV-2007	Description
	<p>10' DC Extension Power Cord</p>
UV-2014	Description
	<p>Bolt-on Power Cord for Magnum</p>
UV-2015	Description
	<p>Bolt-on Power Cord for Magnum-GO</p> <p><i>(Note: All REL Magnum Series lamps manufactured after 6-1-2023 are fitted with a UV-2015; and all REL Liquid Series lamps manufactured after 10-1-2024 are fitted with a UV-2015.)</i></p>
UV-2016	Description
	<p>Domer & Ding Ring Kit</p>
UV-2021	Description
	<p>Case with foam and label NSN: 6240-01-700-3159</p>

UV-2023	Description
	120/240V, 60W DC Power Supply
UV-2030	Description
	Profusion 12" Connecting kit. (includes joining plate and hardware)
UV-2031	Description
	120/240V, 120W Power Supply (4-7 Profusion Modules)
UV-2120	Description
	2-Meter Light Guide
UV-2120DH	Description
	2-Meter Light Guide for Liquid Stylus
UV-4010	Description
	Swivel Mount Lamp Holder

UV-4015	Description
	Profusion Hanging Hardware Kit
UV-4020	Description
	Profusion Shield Kit
UV-4200	Description
	Profusion Switch Block (includes power supply)
UV-7000	Description
	Spray Can Fixture (Hands-Free Applicator)
UV-7100	Description
	Wall Mount Power Supply, 25W

UV-7400	Description
	<p>Snapshot-UV includes GoPro™ HERO9, mounting bracket, remote, wrench, 2 batteries with charger, 64GB SD card, and 2 USB-C cords.</p>
TRM-025	Description
	<p>Tripod with adjustable ball head, ARCA adapter</p>
TRM-100	Description
	<p>Tripod Kit, Adjustable Tripod with ball head, 12" - 62" height, 27lb capacity, ARCA adapter</p>
UV-5420	Description
	<p>Battery Pair for Nomad-Ascent and Nomad-Eclipse (set of 2 batteries with charging cable)</p>

UV-5421	Description
	USB Charger for Nomad-Ascent and Nomad-Eclipse batteries
UV-5422	Description
	8-Place Battery Charger for Nomad-Ascent & Nomad Eclipse
UV-5424	Description
	Head Band for Nomad-Ascent and Nomad-Eclipse
UV-5004	Description
	Head Band Mount Adapter only

<p>UV-5425</p>	<p>Description</p>
	<p>Belt Clip for Nomad-Ascent and Nomad-Eclipse</p>
<p>470-00007</p>	<p>Description</p>
	<p>120 Volt M18 Battery Charger</p>
<p>470-00008</p>	<p>Description</p>
	<p>M18 Battery, 2.0 amp hour</p>

<p>250-00103</p>	<p>Description</p>
<p>Two rectangular panels, one slightly behind the other, showing a dark surface with a blue light reflection.</p>	<p>REL TAM Panel - Twin (Polished)</p>
<p>250-00104</p>	<p>Description</p>
<p>A single rectangular panel showing a dark surface with a blue light reflection.</p>	<p>REL TAM Panel - Single (Polished)</p>
<p>250-00105</p>	<p>Description</p>
<p>A single rectangular panel showing a dark surface with a blue light reflection.</p>	<p>REL TAM Panel - Single (Grit)</p>



relinc.com



REL

REL, Inc.
57640 North Eleventh St.
Calumet, MI 49913
USA

906-337-3018
rel@relinc.com

 **MADE IN
THE USA**

relinc.com